

LASERPOINT 3

User Manual & Assembly Instructions



USCutter 

IMPORTANT SAFETY INSTRUCTIONS



Do not place any magnetic objects in the vicinity of the cutting head; otherwise uniform contact Force is not ensured.

Do not remove the connection cable to the computer while plotting is in progress.

Do not reach into the unit with your hands when the power is connected.

Never open the housing or attempt to modify the unit unless instructed to do so by a qualified technician.

Ensure that liquids and metal objects do not get into the cutter.

Ensure that the wall socket used is grounded and protected with a ground fault switch.

Ensure that the connected voltage (110V) does not deviate by more than $\pm 10\%$. Otherwise install a voltage stabilizer.

Never reach into the unit in the vicinity of the blade holder during the cutting operation!

Discontinue any printing jobs in progress before readjusting the blade holder!

Always ensure that the vinyl cutter is out of reach of children during operation and never leave the unit or individual parts of it switched on without supervision.

Do not touch the tip of the sliding blade to avoid injury.

Always place the unit on a stable base to prevent it from falling down.

Do not operate the unit during thunderstorms; it can be damaged or destroyed by lightning.

- 1 Intro
- 4 Where to use and store your vinyl cutter
- 5 What's in the box
- 6 Assembling the stand
- 10 Getting to know your cutter
- 12 Connecting to a computer
- 14 Setting up media
- 20 Blade set up
- 21 Control Panel
- 22 Making your first test cut
- 24 Contour cutting
- 26 Troubleshooting
- 28 Maintenance
- 29 Cut and place vinyl like a pro



Thank you for purchasing the Laserpoint3 vinyl cutter. Please read this manual completely and keep it in a safe place for future reference.

For Accessories, Supplies, and replacement parts please visit our website at www.uscutter.com

Where to use and store the vinyl Cutter

Location, Location, Location! It's not just important for real estate. Where your vinyl cutter "lives" in your home or business is a vitally important element of your success.

- 1 You need access to a 110 volt grounded electrical outlet. That's the standard household kind with three holes, not two. Be safe... don't plug your cutter into an already over-crowded powerstrip or system of extension cords.
- 2 Dust and dirt will limit the useful life of your cutter. If you use it in a dusty or dirty environment the cooling fans will suck in the dust and it will get inside the machine and gum up the works.
- 3 Operate on a stable surface. A solid flat surface is needed for your vinyl cutter to do its best work. If it wobbles or vibrates during operation your cut is not going to be as sharp and clean as it could be.
- 4 Access is important. The Laserpoint3 cutter is a large machine, but it doesn't belong in the corner during use. You'll need to access the front and back of the cutter to operate it and change the vinyl rolls.
- 5 There will be some noise when the cutter is in use. Take that into account when you locate your vinyl cutting headquarters.
- 6 Position the cutter near enough to your computer to be able to attach it via USB cable or 9-pin serial cable. Internet access will be necessary for downloading drivers and software.

Before starting work, please check whether the following items are all present.



Power cord

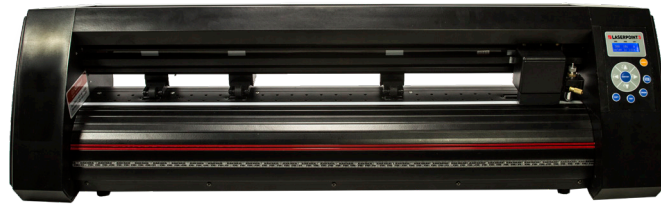

Cutter



OR



Only one of these SW download cards



Blade box



Blade holder



Pen tool



Serial cable



USB cable

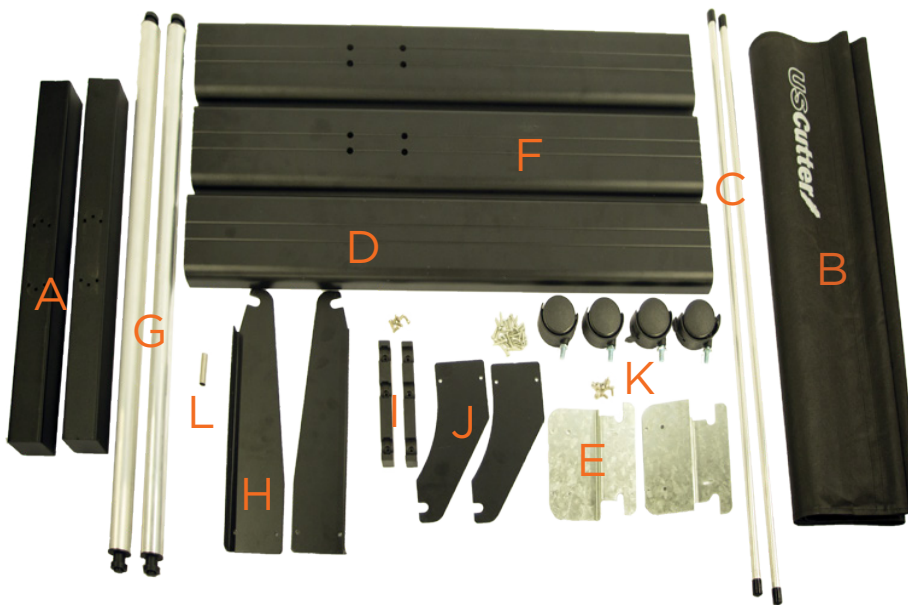

Stand Items:

- A: Foot x2
- B: Catch Basket x1
- C: Catch Bars x2
- D: Cross Brace x1
- E: Mount Bracket x2
- F: Leg x2
- G: Roller Bars x2
- H: Roller Bracket x2
- I: Roller Holders x2
- J: Basket Bracket x2
- K: Casters x4
- L: Screw Guide x1

If any parts seem to be missing from your package please contact support @1-888-975-2047

Assembling the stand

Before you begin:

Read the assembly instructions from beginning to end. Give yourself plenty of time. Gather the tools you'll need that aren't included in the box:

1. A Phillips head screwdriver.

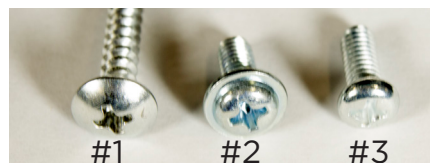

Step 1.

Attach the feet (A) to the legs (F).

This is the leg:

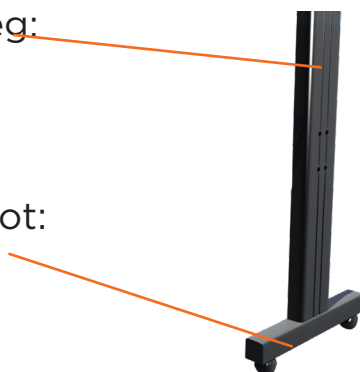

This is the foot:

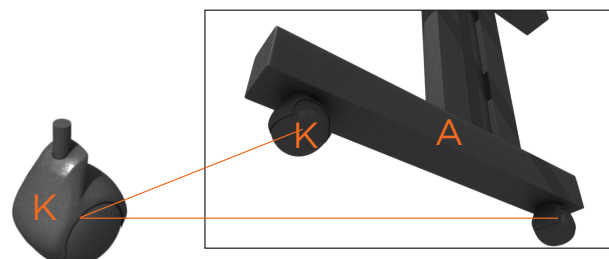
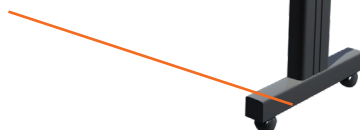

Attach the wheels (K). Simply screw them into the bottom of the stand feet(A)., two wheels for each foot. You can do this before or after attaching the foot to the leg.

Attach the foot to the leg with four #1 screws.

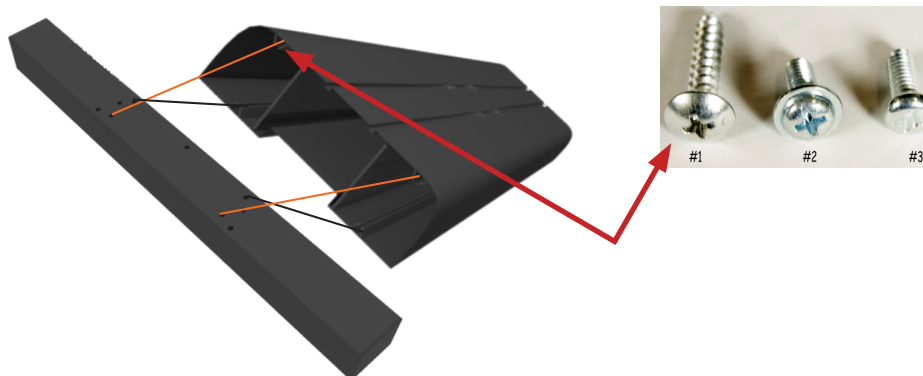

Notice there are more than four holes on the foot.

Line up the foot and the leg so that the four holes in the leg that look like this line up with the four holes on the foot.

Which end of the leg do I attach the foot?

Good question. See those two holes that are further toward one end of the leg? That's where your cross piece is going to attach and hold the two legs together. Attach the foot to the other end.

Also, note the use of the tubular screw guide and how to place it in the leg holes when attaching the leg to the cross beam. If you cannot find your screw guide, you can use a large drinking straw or thick milkshake straw instead.

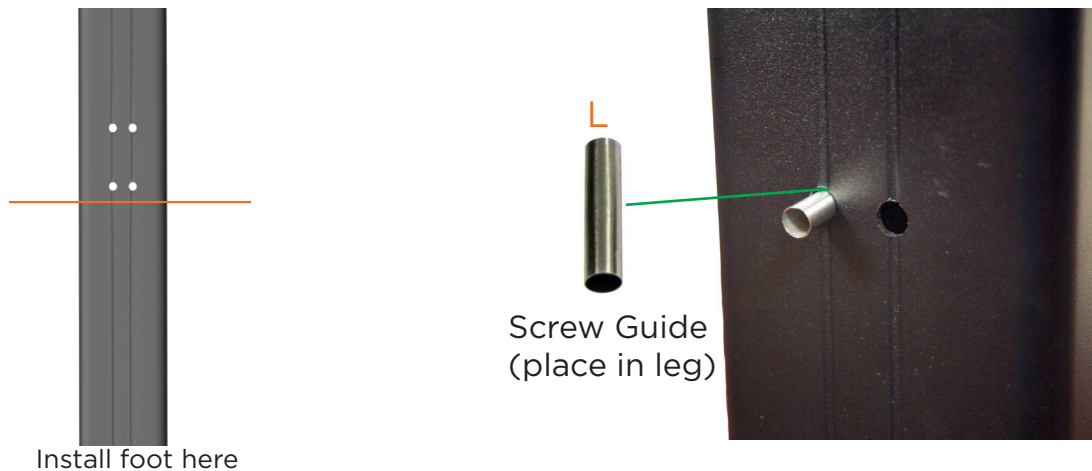

One side is rounded and the other has sharp corners? Which side should face out?

The rounded edge side should face out. If you look closely at the holes you will see that one side is bigger than the other. The small holes will attach the cross piece and you'll screw them in through the larger hole.

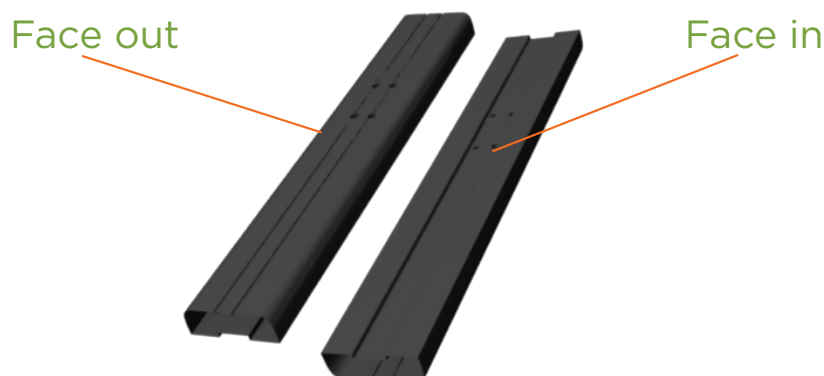

Attach the foot to the leg with four #1 screws using the Phillips screwdriver. Repeat with the other leg and foot making sure the rounded edge faces out and the holes for the cross piece are close to the top.

Assembling the stand

Step 2.

Attach the cross beam (D) to the legs (F) with 8 #1 screws (4 for each leg).

This is where making use of a chair or bench to hold the cross piece in place while you attach the first leg will come in handy.

We've got the rounded edge and sharp edge situation again? Which way do I orient the crossbeam?

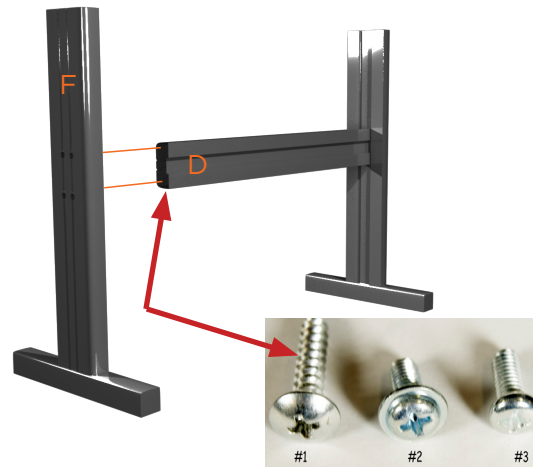

It actually doesn't matter, but most people consider placing the rounded edge facing the front more aesthetically pleasing.

Here you will need to use the tubular screw guide (L) to keep the #1 screws from dropping down the leg when you attach the cross beam to the leg.



Step 3.

Now let's mount the roller brackets (H) to the legs (F). They'll attach at the crosspiece and will create a place for the rollers to sit.

NOTE: If your roller brackets arrived in four pieces instead of two, simply attach the black plastic roller holders (I) to the metal brackets (H) with those extra six #3 screws (the smallest ones).

TIP: You can mount the black plastic roller holders with the twin slots either closer or further from the cutter depending on size of rolls you use most often. Just flip the roller holder and leave out the small screw from the center position.

Use 4 #2 screws (2 on each side) to attach the roller brackets to the stand legs. The metal brackets have a "lip" which the roller guide sits on. When you attach the bracket, make sure the lip faces inward so that the brackets are completely inside the span of the legs

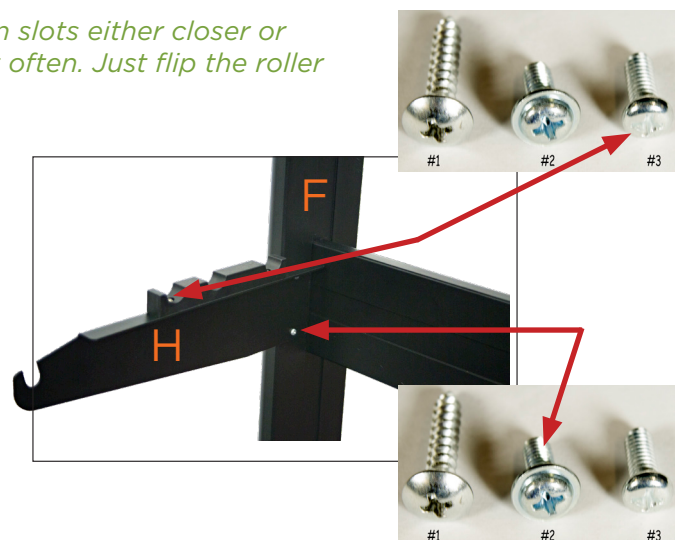

Step 4.

Attach the mounting brackets (E) to the top of the legs (F). This is where you will mount your Laserpoint3 Cutter.

Use 8 #1 screws (4 on each bracket) to attach the mounting brackets to the top of the legs. The brackets have a staircase-like shape. you will screw the lower “stair” to the stand leg and will attach your Cutter to the upper “stair” in a later step.

Some cutters will have an optional mounting strategy that allows attachment of the cutter via two thumbscrews that screw into the bottom of the cutter. The mounting bracket may be slightly different for these models.

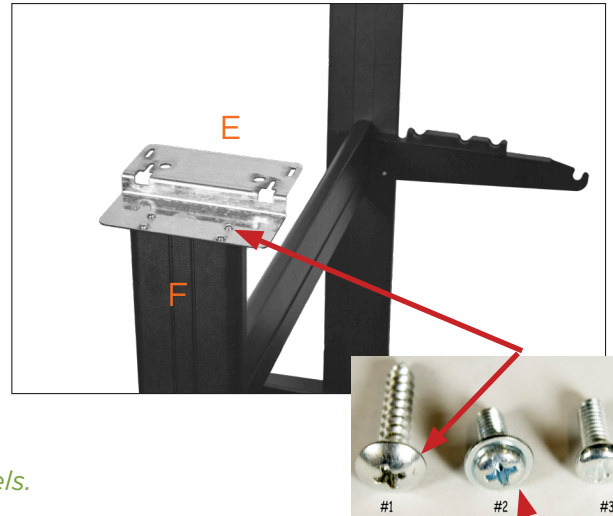

Step 5.

Attach the front catchbasket bracket to the leg using 4 #2 screws (2 on each bracket).

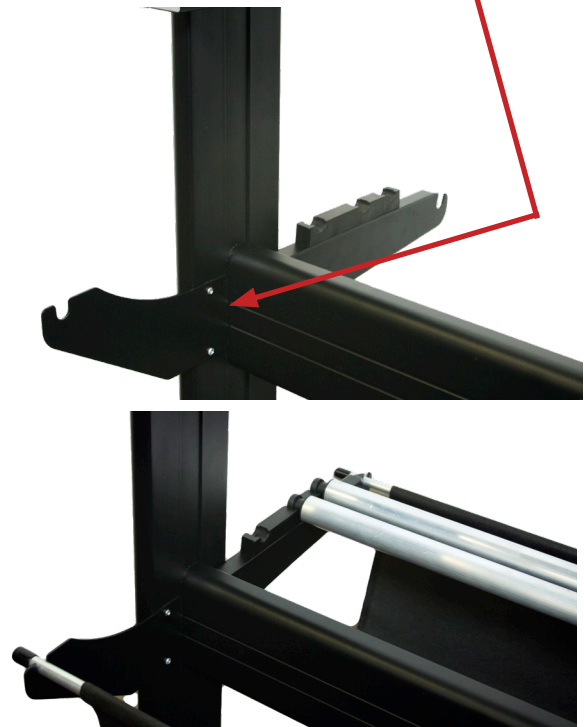

Step 6.

Thread the catch basket poles through the catchbasket and position the catch basket in the front and back grooves of the basket brackets. Place roller bars in position. If roller bars seem too short, brackets in Step3 need to swap sides.

Step 7.

In order to mount the cutter to the mounting brackets (E) on the stand, you first need to remove the feet from your cutter. With your cutter sitting on the mounting bracket, re-attach the feet so that they secure the cutter to the stand.

Alternatively you can remove the feet and just use screws and washers to secure the cutter to the stand.



Getting to know your cutter

Before you start cutting, you should familiarize yourself with the cutter along with its basic parts and functions.

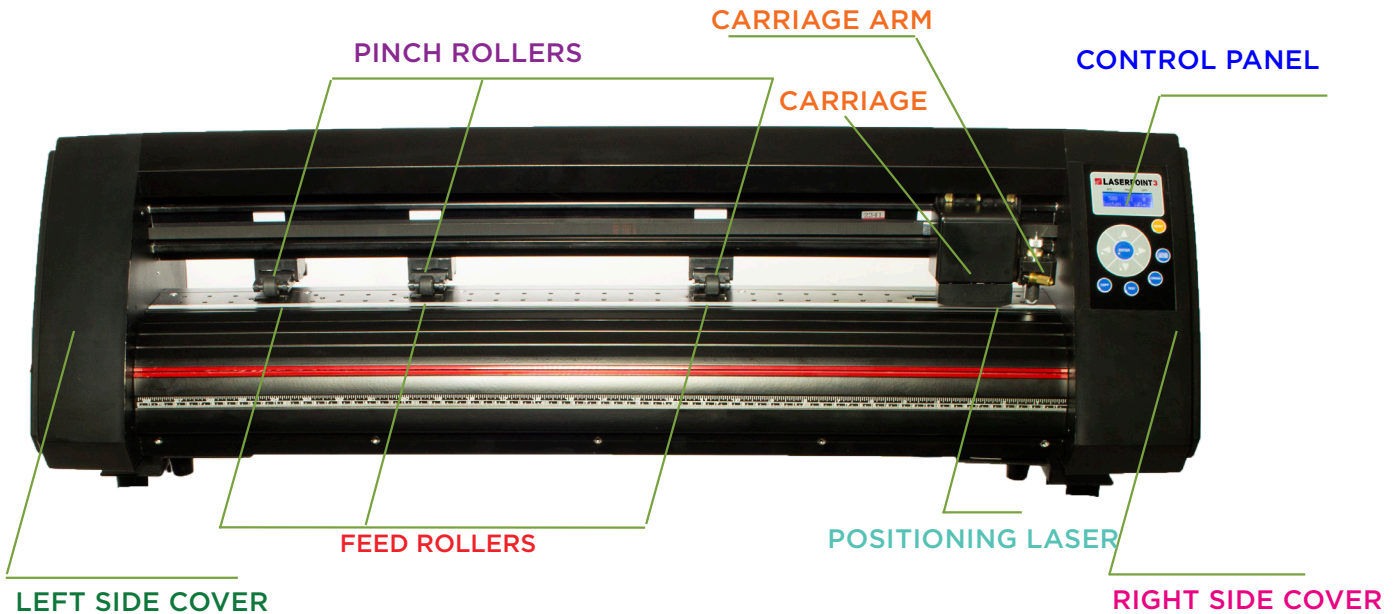

CONTROL PANEL

Used to provide input directly to the cutter. Covered in detail in the “Control Panel” section of this manual.

CARRIAGE ARM

Holds the blade (or pen) carriage.

PINCH ROLLERS

Holds the media tightly to the feed roller below.

FEED ROLLERS

Positions the cutting material during operation.

POSITIONING LASER

Used by the cutter to determine the location of cut contours

LEFT SIDE COVER

Contains the power cable port, power switch, and fuse cartridge for the cutter.

RIGHT SIDE COVER

Contains the USB and serial cable ports for the cutter.

RIGHT SIDE VIEW

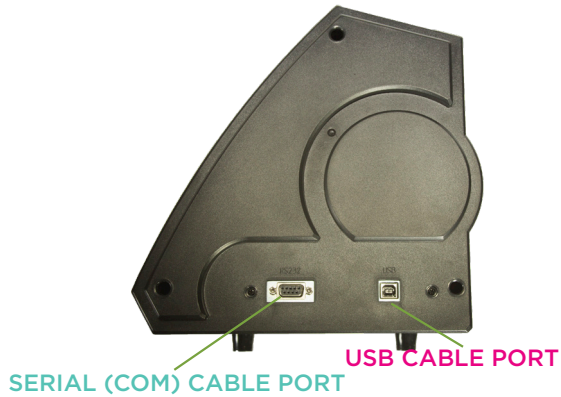

USB CABLE PORT

Used to connect a USB cable from the cutter to a computer. (Best option)

SERIAL (COM) CABLE PORT

Used to connect a serial cable from the cutter to a computer.

NOTE: Only one connection to the PC is needed, either USB or serial. It is recommended that you use USB.

LEFT SIDE VIEW

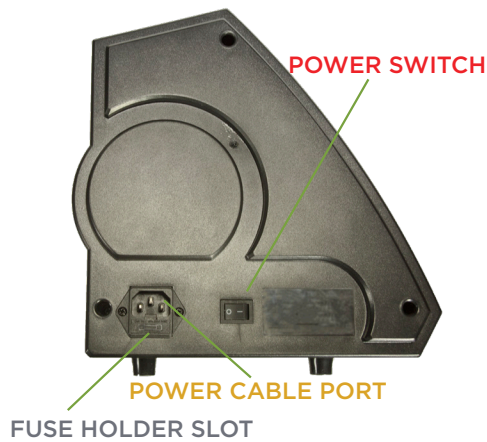

POWER CABLE PORT

Used to connect a power cable from the cutter to a wall outlet or surge protector.

POWER SWITCH

Main power switch for turning the power of the cutter on (1) or off (0).

FUSE HOLDER SLOT

Allows access to the fuse inside of the cutter.

CARRIAGE SLOT

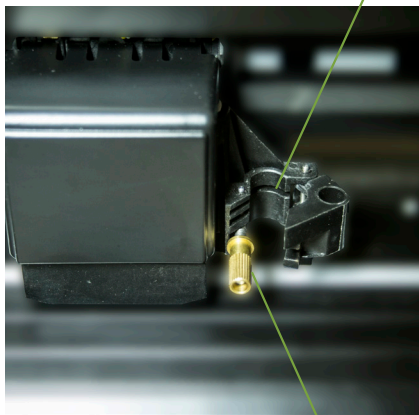

CARRIAGE SLOT

Holds the blade carriage in place.

LOCKING KNOB

Allows access to the blade/pen carriage slots for exchanging/replacing carriages.

Connecting the cutter to a computer

Attach the power cord to the cutter and then plug in the unit and turn on the power.



If using the USB Cable to connect your cutter to a computer:
(USB is the recommended connection method)

In most cases, all needed PC drivers will be preloaded in VinylMaster. If you need to download and install drivers for the USB connection to work properly go to www.uscuttersupport.com and select the driver that supports your Windows version.



If using the Serial Cable to connect your cutter to a computer:

If you are using a Serial Cable to connect your cutter to a computer then no further setup is necessary. Simply connect one end of the cable to the cutter and the other end to a computer and setup is complete. If you have more than one serial connection on your computer or you are experiencing communication issues between your cutter and computer then you may wish to verify that the correct COM port is being used in your software setup, but for most users the COM port will be COM1.

NOTE: Only one connection method (USB or Serial) is needed. USB is recommended.

INSTALLING VINYL MASTER SOFTWARE (If purchased)

Your Vinyl Cutter may have optionally come bundled with **VinylMaster Cut** software which is Windows compatible. Software is download only (no CD).

Download **VinylMaster Cut** software at www.uscutter.com/download. You will need the key code packaged with this cutter to activate the software. You may need to download drivers to support your operating system. Drivers are available at <http://support.uscutter.com>

Training for VinylMaster is all done via short videos accessed through the software. To access the videos, click on the **SUPPORT** link in VinylMaster, then further on **HELP TOPICS**.

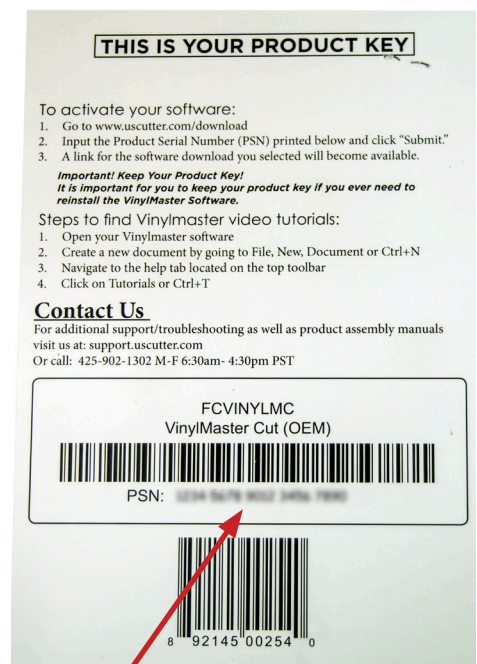

KEY CODE

INSTALLING SURE CUTS A LOT SOFTWARE (If purchased)

Your Vinyl Cutter may have optionally been bundled with **SURE CUTS A LOT** sw. Software is download only (no CD). If purchased, you should have received a card with a download code, which will allow you to download and activate the software.

Download **SURE CUTS A LOT** sw: <http://www.craftedge.com/redeem/scal4pro>
Scratch away the covered area on the back of the card to reveal your download code. Note that the download code on the scratch card is different from the Product Serial Number which you will receive via email at download.

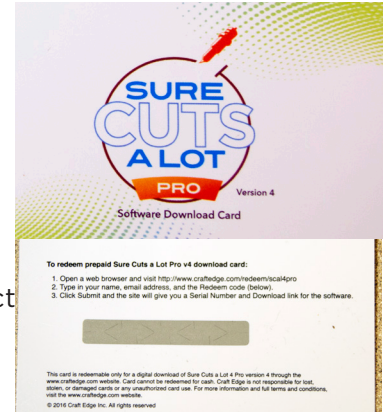

To add Laserpoint3 in Sure Cuts A Lot software, select Cutter option from the top menu,

Follow the pull down to My Cutter, Manage Cutters and select USCutter from the bottom of the pull down list.

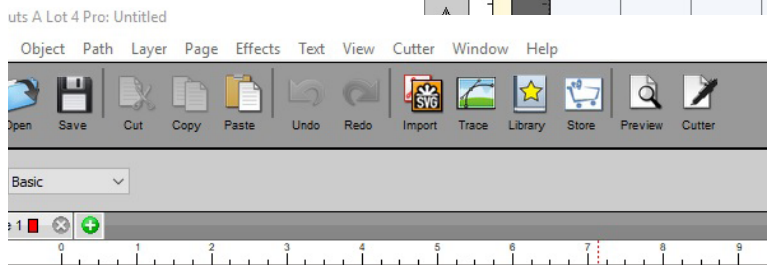
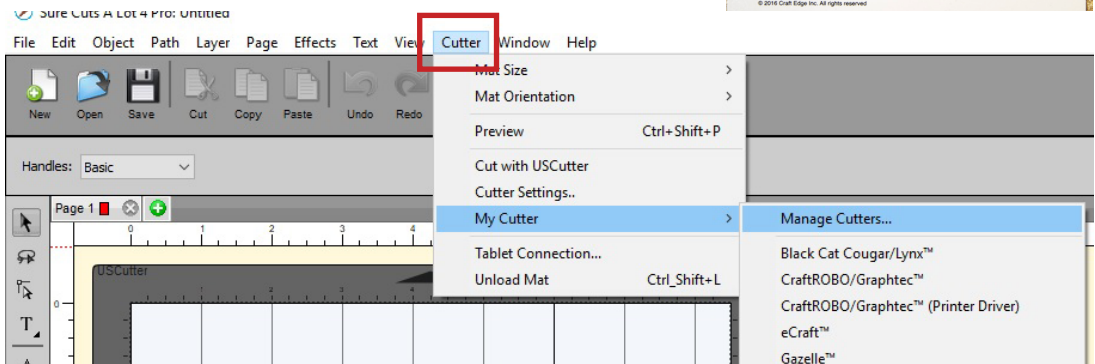

Within Manage My Cutters menu, select Company=USCutter and Model=Laserpoint3.

Click on the Add to List button so That USCutter appears in the list on the left.

Laserpoint3 will appear as a pull-down selection in the Cut Settings menu as seen in the following frame

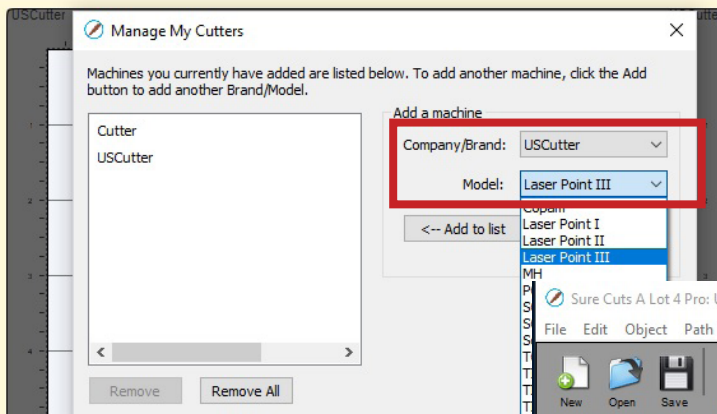

Click on the Cutter Icon to open the Cut Settings menu. The General tab should now show Laserpoint3 as the selected cutter.

Set the connection to USB and the port to auto-detect. (assuming you are using a USB connection).

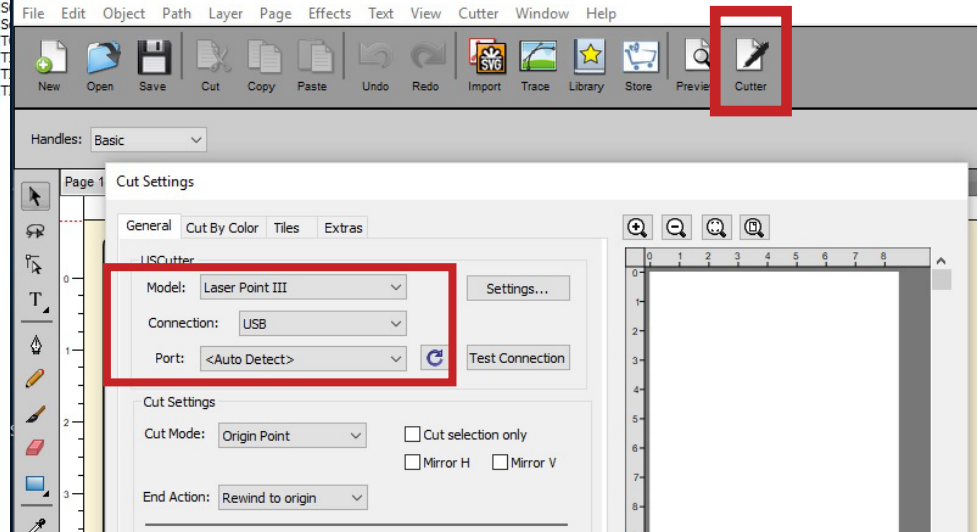

Setting up Media

Place the roll on top of the stand rollers.

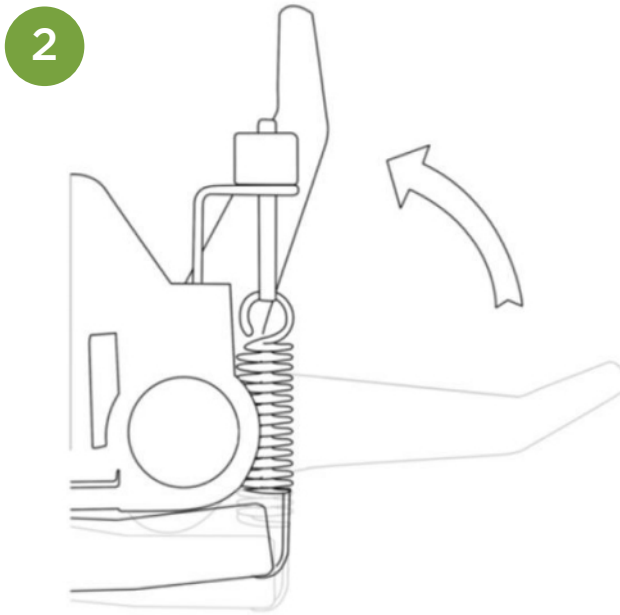
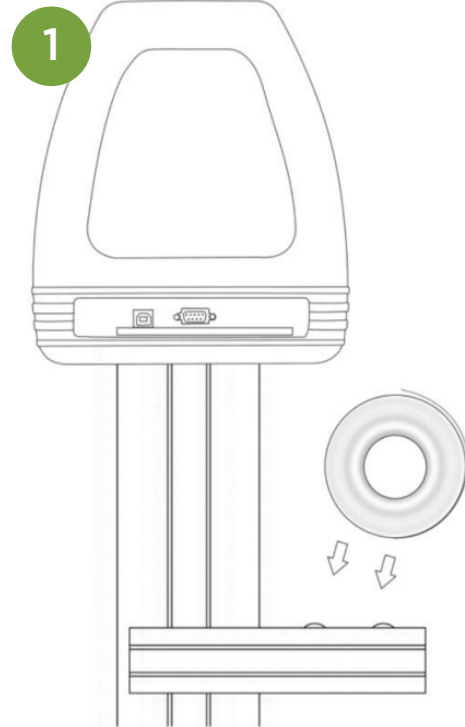

Release the pinch rollers release levers.

Feed the vinyl underneath the pinch rollers (if working from a single sheet instead of a roll, the vinyl can also be feed from the front).



Adjust the pinch rollers so there is one roller located on each side of the vinyl (and, on models with 3 or more rollers, one roller near the center). Avoid lowering a pinch roller to the gap between the two feed rollers.

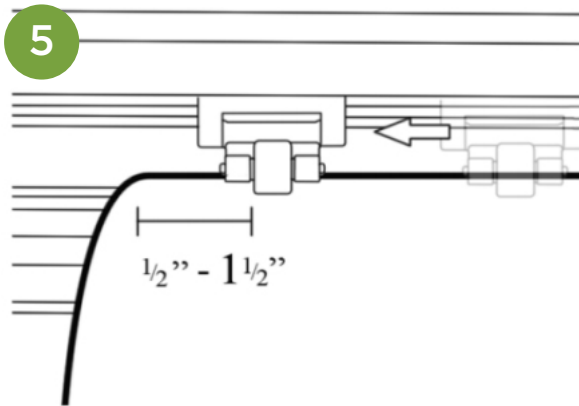
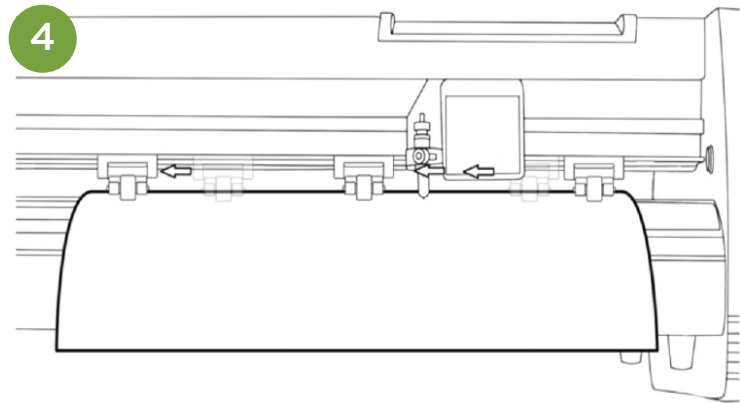

Leave a gap of between $1/2'' - 1 1/2''$ from the edge of the roller and the edge of the vinyl on both sides.

Engage the Pinch Rollers by pushing down on the Pinch Roller Release Levers.

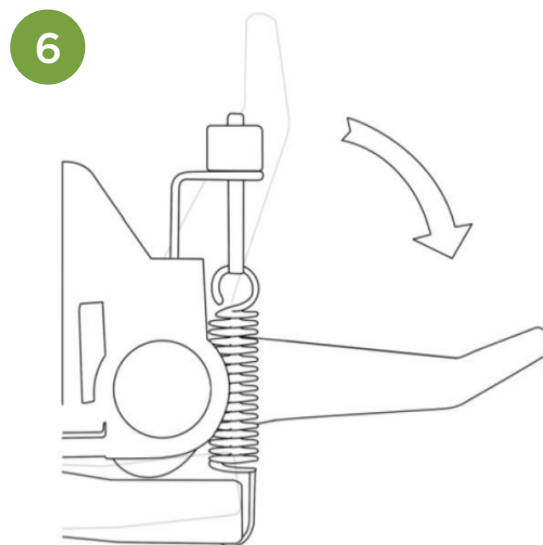

If the cutter is not already on, turn it on now.

Installing VinylMaster drivers

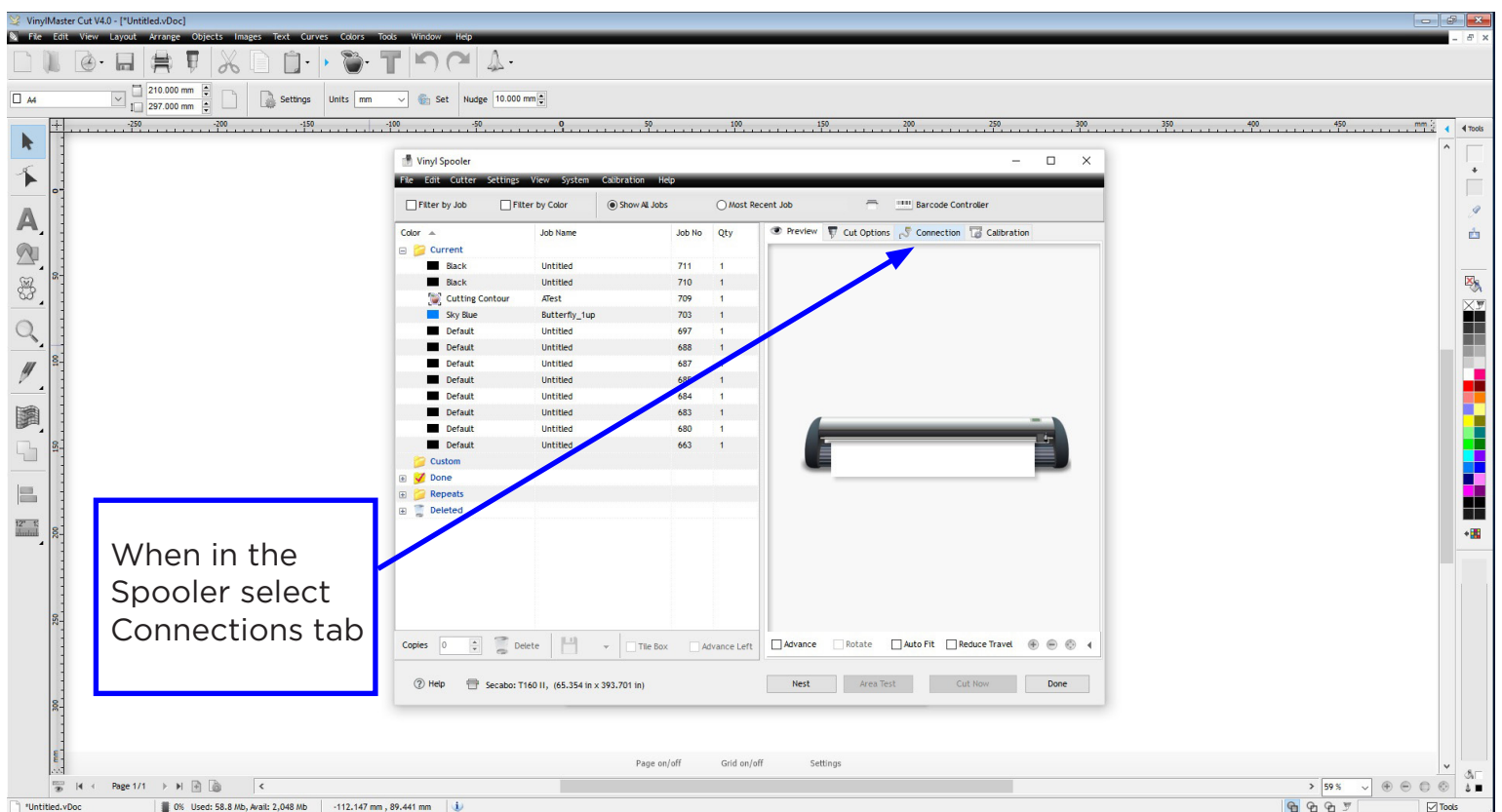
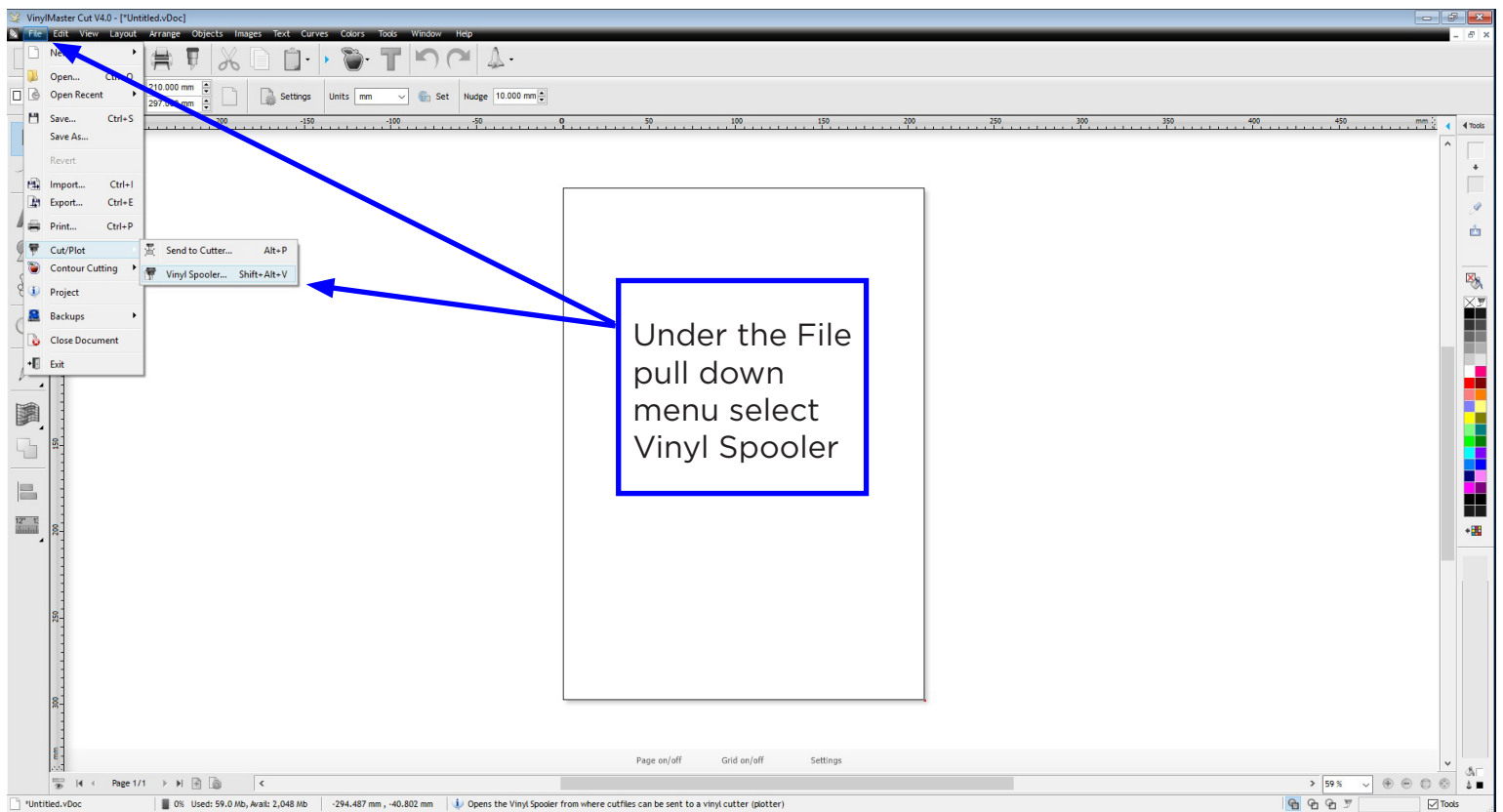

Installing VinylMaster drivers

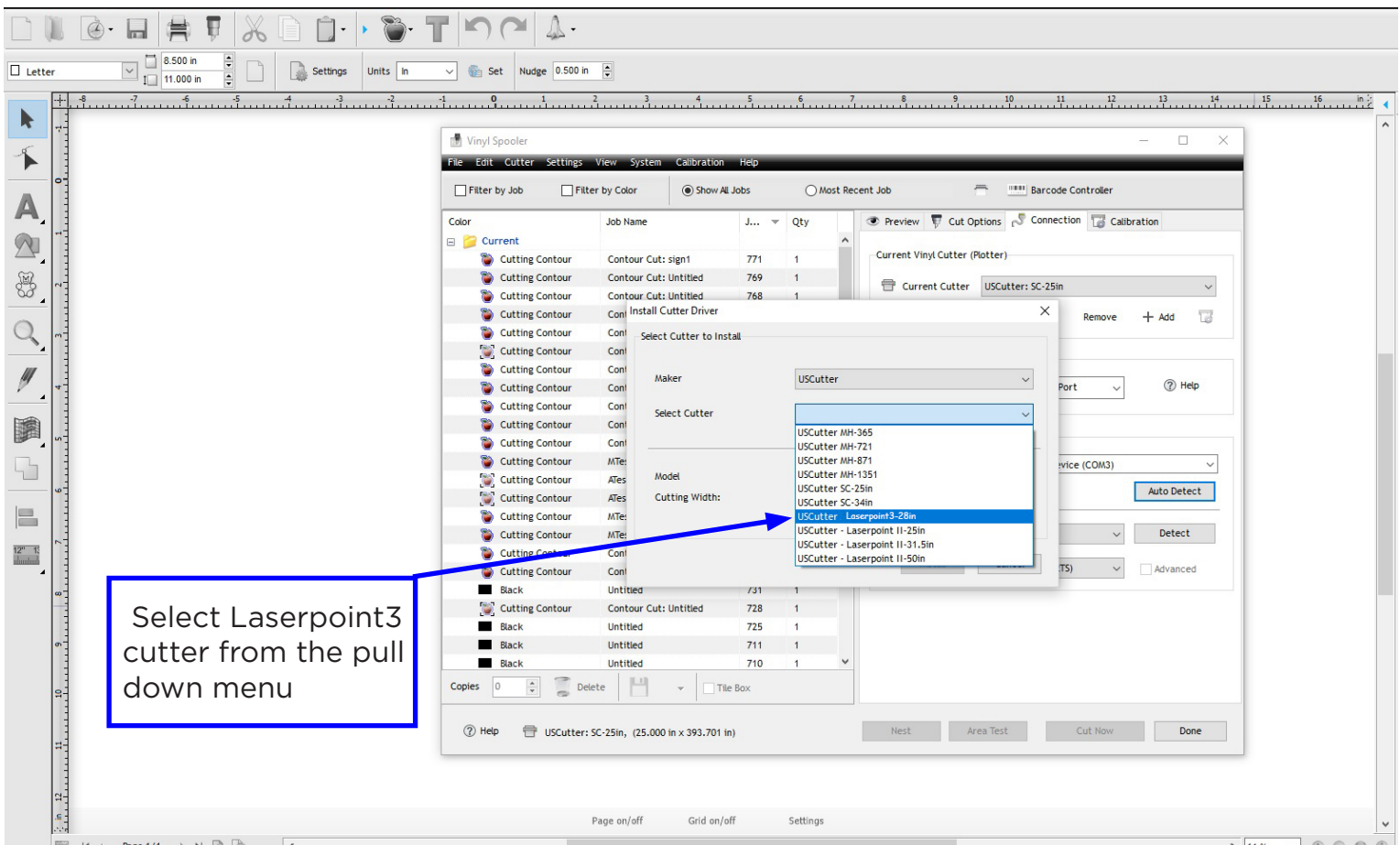
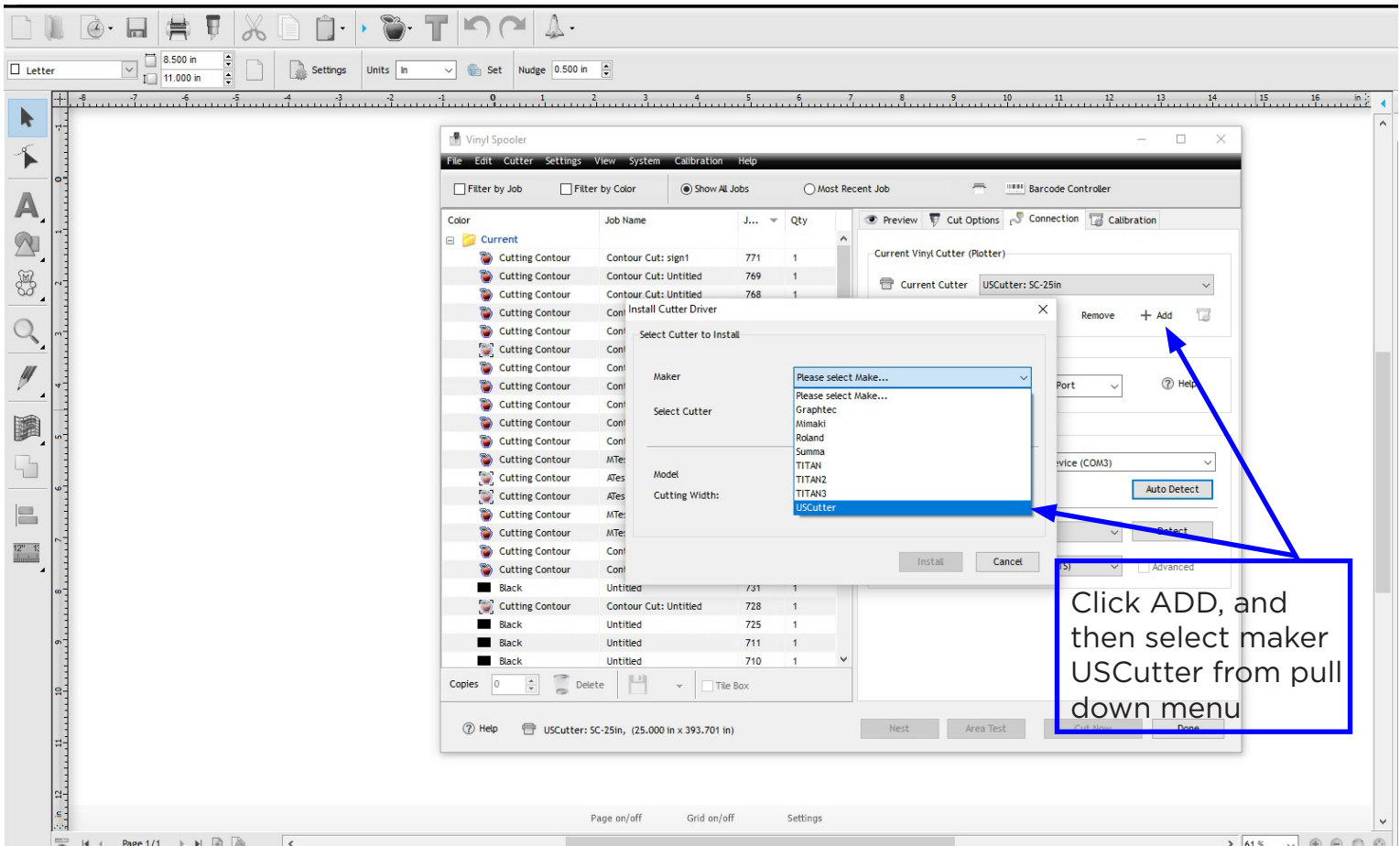

Installing VinylMaster drivers

Verify that Direct COM Port appears and then select Auto Detect

Color	Job Name	J...	Qty
Current			
Cutting Contour	Contour Cut: sign1	771	1
Cutting Contour	Contour Cut: Untitled	769	1
Cutting Contour	Contour Cut: Untitled	768	1
Cutting Contour	Contour Cut: Untitled	767	1
Cutting Contour	Contour Cut: Untitled	765	1
Cutting Contour	Contour Cut: Untitled	763	1
Cutting Contour	Contour Cut: Untitled	762	1
Cutting Contour	Contour Cut: Untitled	758	1
Cutting Contour	Contour Cut: Untitled	757	1
Cutting Contour	Contour Cut: Untitled	756	1
Cutting Contour	Contour Cut: Untitled	752	1
Cutting Contour	MTest7	746	1
Cutting Contour	MTest4	747	1
Cutting Contour	MTest5	744	1
Cutting Contour	MTest3	741	1
Cutting Contour	MTest1	738	1
Cutting Contour	Contour Cut: Untitled	735	1
Cutting Contour	Contour Cut: Untitled	733	1
Black	Untitled	731	1
Cutting Contour	Contour Cut: Untitled	728	1
Black	Untitled	725	1
Black	Untitled	711	1
Black	Untitled	710	1

Follow the PC prompts to turn off/on and click Next

Tip: Disconnecting and reconnecting the USB cable at the PC is often more reliable than power cycling

Detect Connection Wizard

Detect Device

This wizard will attempt to automatically detect your device connection.

Step 1. Turn Off Device

Please turn OFF the device, then click next to continue.

If you have trouble detecting the device, try unplugging the cable from the computer as well as turning it off.

Installing VinylMaster drivers

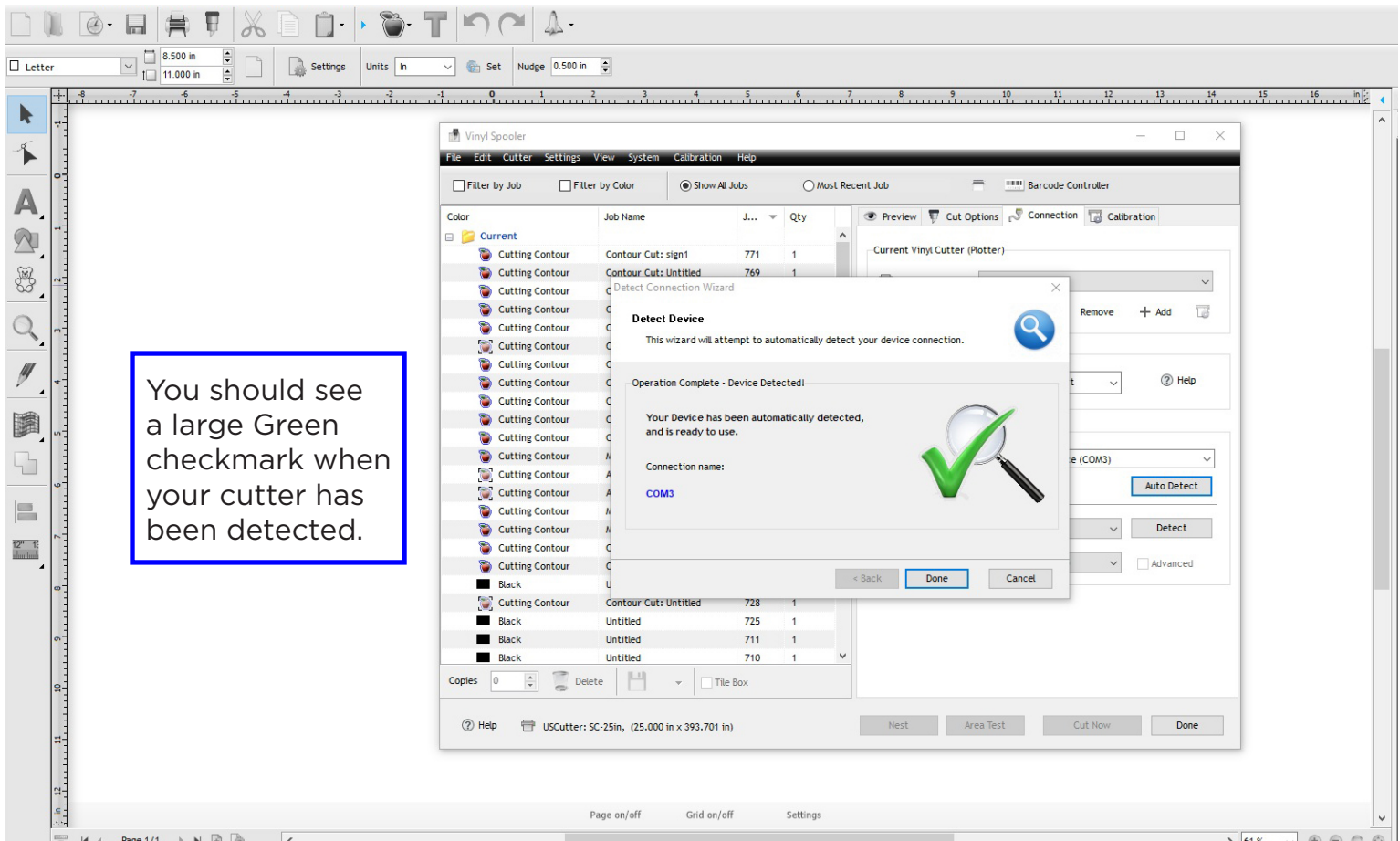

The latest release of Vinyl Master Cut has a new installation wizard that may already have installed the correct cutter driver for you. If your cutter driver is already installed and functional via the wizard, you may use the above instructions whenever you wish to add a new cutter model.

Newer versions of Vinyl Master Cut also have extensive help menus and context sensitive videos that will help train you and help guide you through any software issues you may experience.

You can find additional information about VinylMaster setup and configuration at:
<https://www.uscutter.com/VinylMaster-Support>

Blade Set Up

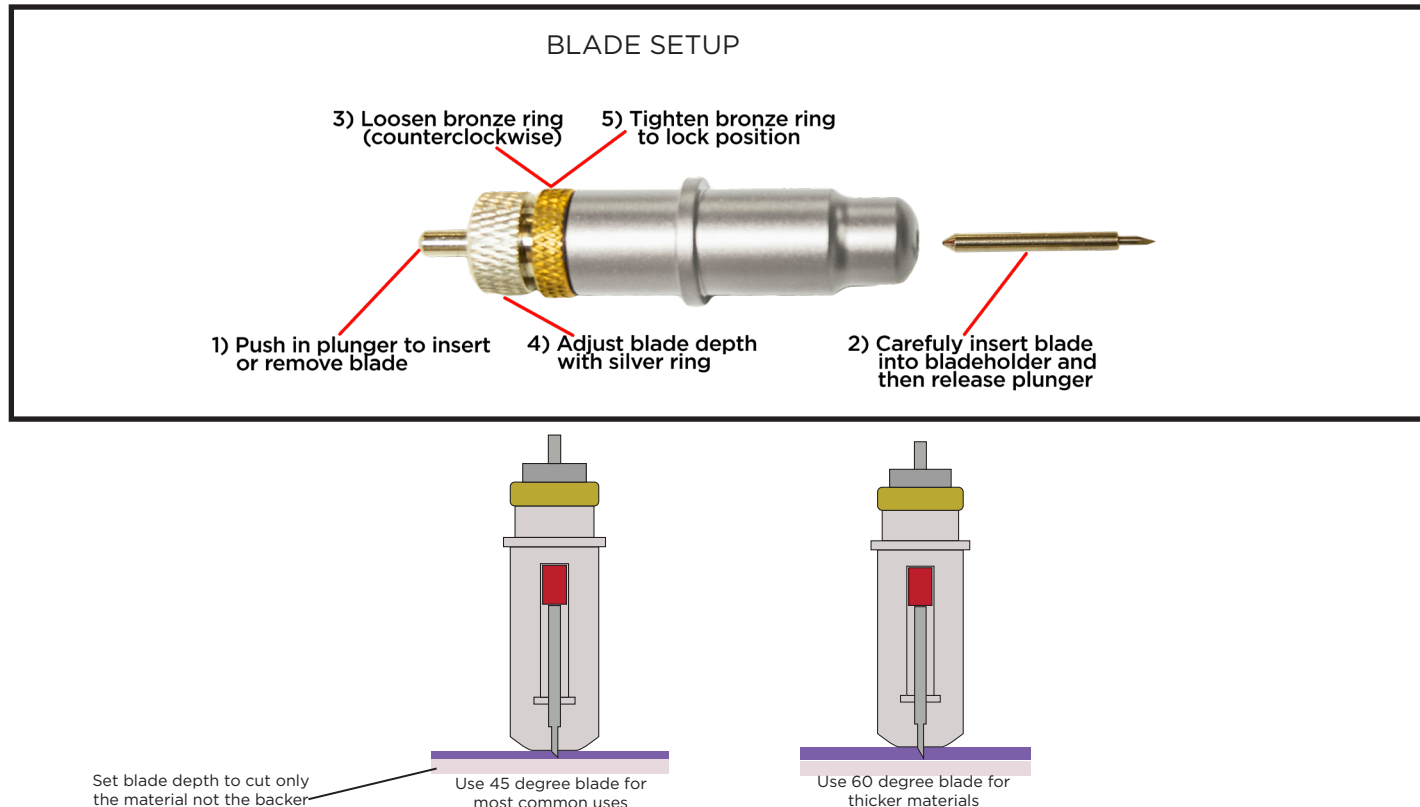

TIPS FOR GETTING OPTIMAL RESULTS

- Use a short blade depth. You only need to extend the blade 1/2 the thickness of a credit card. New users tend to expose too much blade. The idea is to cut through only the top layer of the vinyl and to leave the backing layer with only minimal scratches. This allows you to weed the top layer off the backing easily. If corners or small detail do not cut all the way through, consider increasing the force before extending the blade depth. If you can feel cut lines on the backer underneath the vinyl, blade depth should be reduced. You only need to extend the blade depth or use the 60 degree (blue tip) blade for thicker materials.
- Set a safe and reliable speed. **A good starting value for speed is 300.** Once you have accumulated experience with the material you are cutting and production time becomes a factor, you can look to increase the speed. Also, intricate jobs typically require lower speeds.
- Set the correct force. **A good starting value for force is 70,** then you can adjust force up or down depending on how thick/dense the material is to be cut. With test material in place, use the the Test Cut icon on the cutter's main screen to cut a small square in your test material to see that it cuts all the way through and can be weeded easily
- Align the pinch rollers so that they are under the guide arrows. The pinch rollers must align with the gritted sections on the bottom roller.
- A cutting mat (optional, purchased separately) can be used when cutting materials that do not have their own backing. Place your material on the cutting mat so that the pinch rollers roll on the mat, not the material. Move unused pinch rollers out of the way so they don't touch the parts of the material being cut. Use a brayer roller to flatten your material on the sticky part of the cutting mat or tape the edges of thicker materials to the cutting mat. For wider jobs, it sometimes cannot be avoided and the pinch rollers will need to roll over areas of the material being cut. Typically this is not a problem.
- When cutting long pieces of material it is important to carefully position the material so that it is completely straight and doesn't drift to one side when cutting.

Control Panel

The control panel allows direct control of the cutter state (Local/Paused), change Speed/Force, perform an immediate test cut and make a copy by repeating the last cut job.

“System Is Idle” message on the screen means that the cutter is ready to go.

The various buttons and functions of each button are outlined here.



Some screens/buttons use different terms which all mean the same thing. This might help:
 LOCAL = Idle = Online = Automatic = Waiting for commands from Computer or User at Control Panel
 PAUSE = Paused = Offline = Manual = Waiting for co-ordinates from User at Control Panel

Setting the Origin Point

The origin point of the cutter can be set whenever the cutter is in the PAUSE state by moving the cutter head with the navigation keys on the control panel and then pressing the ORIGIN key. The cutter will store a new origin point at the location of the cutter head and use this point to start cutting. Pressing RESET or power cycling the cutter will clear the current origin point, reposition the cutter head at the Home (0,0) location and store that as the new origin point. An origin point specifies the right and bottom border of where your cut will start.

Setting Speed and Force

You can manually set the speed and force of the cutter when you are in the LOCAL state. Use the up and down arrows to adjust the speed and the left and right arrows to adjust the cutting Force. A typical cutting speed setting is 300, and a typical cutting force setting is 70. Depending on the material you may have to adjust these values for thicker vinyl or intricate cuts. Changing the speed and force while cutting is possible. The cutter may pause briefly and resume cutting once the new settings have been entered.

Making Your First Test Cut

A Basic Guide To Vinyl Cutting

Now that you've got your system fully assembled let's take a moment to test it and also take moment to learn a bit about how to "fine tune" the machine so that it will do quality cuts on the different materials you'll be cutting. To do this we'll do a standard test cut, which when completed will a simple triangle inside of a square. Load the material roll and adjust the pinch rollers. Remember to make sure the top roller is placed so that there is a bottom roller (called the "grit roller") beneath it. Remember to line the material up so that it is moving straight through the feed area, and resist the temptation to run the material close to the edge of the cutter feed area or you increase the risk of a mis-feed that will wrinkle your vinyl. (See the graphic on pages 14 and 15 for an example.)

CHOOSE BLADE

For thin and regular sized media, use a 45° blade.

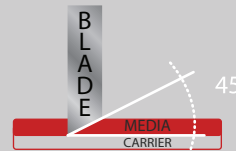

Load the blade so that the length of the blade shown is not longer than the media is thick.

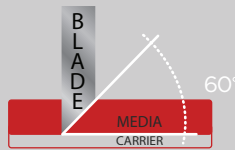

For thicker materials, such as Siser StripFlock, Siser Glitter, and similar heavy stock materials, a 60° blade is needed.



1

2

LOAD MATERIAL



Most vinyl products are loaded from over the top.

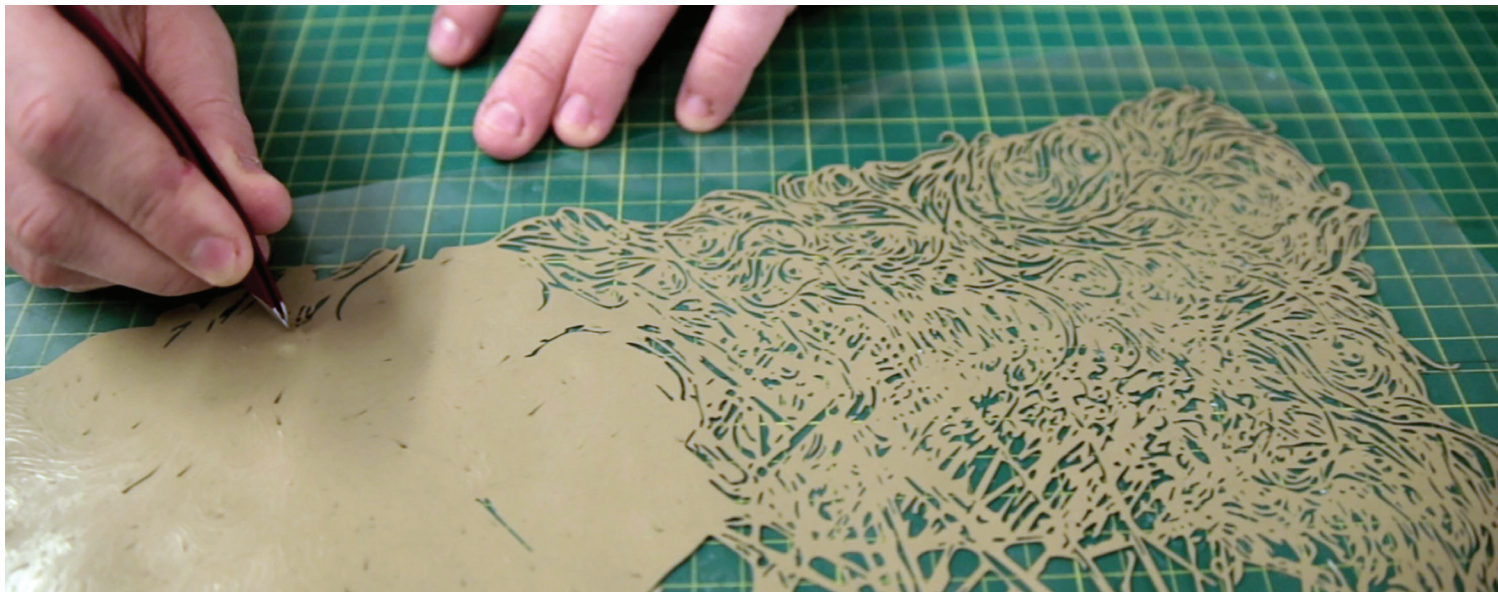

This Test Cut will help you to calibrate the machine for this material. Examine this cut and use a weeding tool or exacto knife to weed the square out while keeping the triangle on the paper. (“Weeding” is the word for removing the cut vinyl in the design.)

Use this simple diagram to make adjustments. There’s a certain amount of trial and error to it at first, but you’ll quickly get a feel for it.

CUT SPEED

This setting determines how fast the design is cut out and is usually measured in millimeters per second.

small intricate designs



DECREASE CUT SPEED

large simpler designs



INCREASE CUT SPEED



FORCE/Force

This setting determines how hard the blade comes down onto the material.

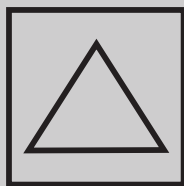

Test Cut

outer square won't weed



INCREASE FORCE

blade digging too far into carrier



DECREASE FORCE

weeds easily with a lightly scored carrier



PERFECT!

Contour Cutting

1

Calibrating the cutter

1. Load a blank piece of paper into the cutter and have the pen tool loaded into the carriage arm.
2. Turn the machine on while holding down the right arrow key on the cutter.
3. Release your finger from the right arrow key once the screen on the cutter says “Welcome...”
4. The screen should say “move to blank”. Use the arrow keys on the cutter to move the pen to the center of the piece of paper and press the origin button.
5. Press the enter key on the cutter. The cutter should draw and scan an “L” shape.
6. The screen of the cutter will display “success” if the calibration happens properly.
7. Press the enter button. You have now successfully performed an on-machine calibration of your Laserpoint 3!

(see link to video on page 25)

2

Printing your image

This section applies when contour cutting:

Load your image into the VinylMaster software. Make sure your art is centered and the size of the cutting mat in your software is the same size as the media you are going to be using. Press Shift+Alt+F to start the Contour Cutting Wizard. Select your printer and make sure you have checked the box that says “Print Registration Marks”. Press “OK” to send the job to your printer. You should now have your printed image with four corner alignment marks. Place media in cutter as shown so that the blade would come down just outside the alignment mark. Set your origin point on the cutter here (just outside the alignment mark).

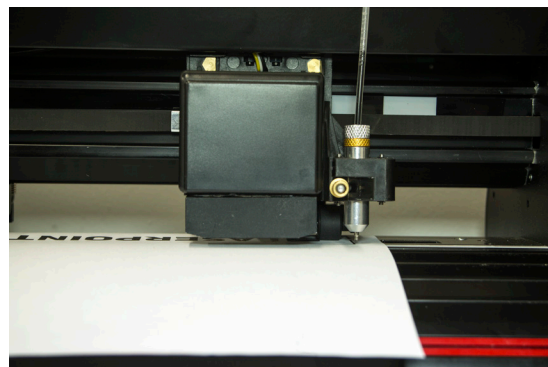
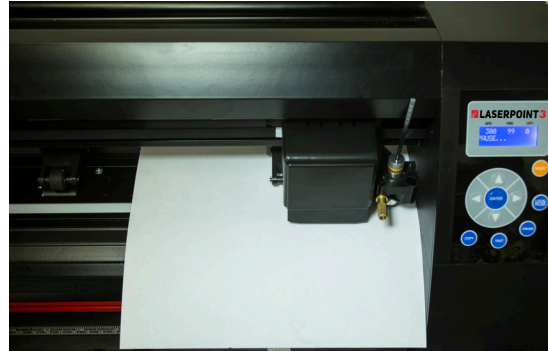

3 Laser aligning registration marks

This section applies when ARMS contour cutting:

Within the Contour Cutting Wizard of VinylMaster, make sure that Cutting Device is set to ARMS (fig 1.)

You should have already previously used Build to create a contour around you image (fig 2). Take the printed image and place the printed artwork with alignment marks in the cutter.

Note the correct orientation of the artwork for ARMS contour cutting (fig 3). The top of the image comes out of the cutter first and shows up side down when viewed from the front of the cutter. In this image the paper has been moved forward - normally the blade tip will be directly beside the alignment mark as seen in figure 4

Using the navigation keys on the cutter, position the blade tip so that it appears just outside the corner shaped alignment mark (fig 4). Press the Origin key on the cutter to set this as your origin point.

Press the Next key on your computer (fig 5). If you have correctly positioned the blade, the cutter will turn on the laser, automatically read all 4 alignment marks and start ARMS contour cutting.

Precision laser alignment matters a great deal when contour cutting. Take the time to get the printed artwork loaded into the cutter perfectly straight.

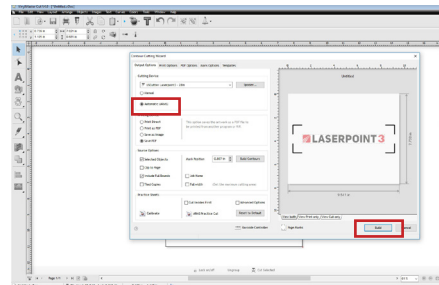

figure 1

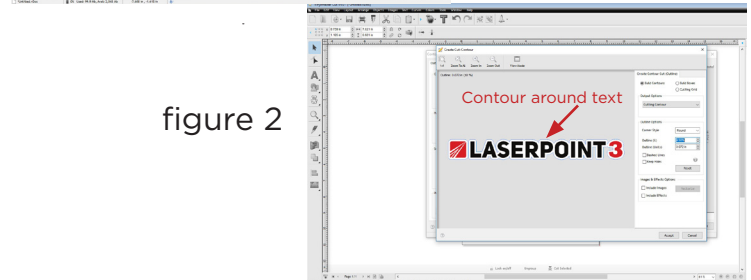

figure 2



figure 3

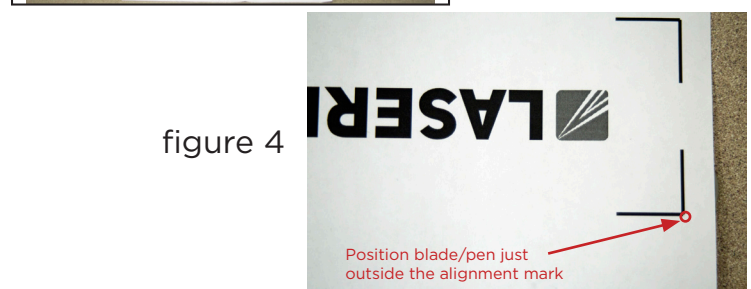

figure 4

Position blade/pen just outside the alignment mark

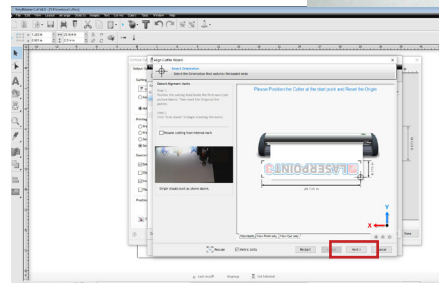

figure 5

Watch this video for step by step instructions of how to calibrate the cutter and perform a contour cut:
<https://support.uscutter.com/support/solutions/articles/14000086258-laserpoint3-contour-cutting-video>

Troubleshooting

PROBLEM

SOLUTION

The cutter performs erratically during cuts, stops cutting before the cut is finished, or cuts lines that do not appear in the design.

Some older computers do not work well when connected via the USB port of the cutters. If you are having problems while cutting and are using the USB cable to connect from your cutter to computer, you may wish to try the serial cable connection to avoid further problems.

After the first cut is made, subsequent cuts are made over the top of the original, or vinyl is fed backwards until it loses contact with the rollers.

After a cut is made, you will need to reset the origin of the cutter. If the origin is not set again, the first origin will remain in the cutter and the cutter will return to this position before making any further cuts. To reset the origin; from the main screen of the cutter, press the Local/Pause button, move the cutting head to desired location and then press the Origin button.

Cuts are jagged or inconsistent.

The Blade may be dulled or damaged. Replace with a new blade and try again. Make sure that the blade can turn freely (by attempting to turn it with your fingers while the release button of the Blade Carriage is pressed).

Adjust the blade depth of the Blade Carriage (page 17) and Force setting on the cutter (page 15) until you are getting solid, uniform cuts. Start with a blade depth of around 1/64th of an inch and a Force setting of 100g and try an increased Force setting before attempting to increase the blade depth.

Slashes are made across the vinyl from the blade movement during cutting.

If the blade is protruding too far from the Blade Carriage then it can score and cut material during normal operations. If this is occurring, the blade needs to be adjusted so that it is protruding a minimal distance from the carriage. Also, check to see that your software is registered correctly.

Vinyl not feeding straight and the rightmost Pinch Roller will not move.

Sometimes, during shipping or movement of the machine, the right pinch roller will become stuck on a screw located on the back of the machine. If this occurs and is affecting your cutting, press forcefully against the pinch roller until it becomes dislodged from its position. If needed, remove the screw to reposition the pinch roller in the desired position.

Cuts are warped and inconsistent.

Sometimes, during shipping or movement of the machine, the Carriage Arm can be dislodged from its track. Make sure that the 2 white wheels behind the carriage arm are both resting securely on top of (not in front) of the track. If the wheels are not on the track, gently lift the carriage arm and press back until both wheels are resting on the track.

ISSUE

Cut has dashes or looks perforated.

EXAMPLE



CAUSE

Damaged cutting strip (groove in strip) or too much blade is exposed (friction build up).

SOLUTION

Replace the cutting strip or decrease the blade depth.

ISSUE

Cut line tapers and not cutting towards the end.

EXAMPLE



CAUSE

Dull blade or blade holder isn't secured properly in slot.

SOLUTION

Replace blade, check the blade force, and secure the blade holder.

ISSUE

Blade is skipping turns and corners.

EXAMPLE



CAUSE

Part of the blade is dragging on its side during turns.

SOLUTION

Clean the inside of the blade holder by coating the blade with WD40 and moving it in and out of the blade holder. Clean off any debris that comes out. Replacement blade holder may be needed.

ISSUE

Corners are not cutting correctly.

EXAMPLE



CAUSE

Offset setting is incorrect.

SOLUTION

Change the offset setting.



Maintenance For Your Cutter

Cutting Strips for your vinyl cutter sit directly under the cutting blade as it moves back and forth across the width of the cutter. Cutting strips will need to be replaced periodically - we recommend it be done every six months if you use your vinyl cutter continuously.

You might need to change out your Cutting Strips sooner if you start experiencing an uneven depth of cut, or your material is peeling up even on slow speeds.

To replace your Cutting Strip:

- USCutter stocks replacement cutting strips. Go to USCUTTER.com and search using the keyword: Cutting Strip.
- Use a weeding tool or other pointed tool to pry up the existing strip. (For best results, start at either end of the strip.)
- Lay replacement into the channel and use a heat gun or hair dryer to heat the strip up as you squeegee it into place.
- Use a knife to trim the ends of the strip so that it fits in the channel.

Cutting Blades wear out with use and the tips of the blades can snap just like the point of a sharp pencil. (This is particularly true of the 60 degree blade.) You should also periodically visibly inspect your blades and if you see visible chips in the edge it's best to replace the blade with a new one. (This is also a good time to wipe away any vinyl debris that has built up inside the blade holder.)

You might also consider the replacement of your blade if you develop problems weeding or otherwise experience problems with cut quality.

Refer to the manual section on Blade Set-up for instructions on how to install replacement blades and remember to dispose of your old blade safely by putting it in an aluminum can or other closed hard container.

A good VINYL CUTTER is just the start...

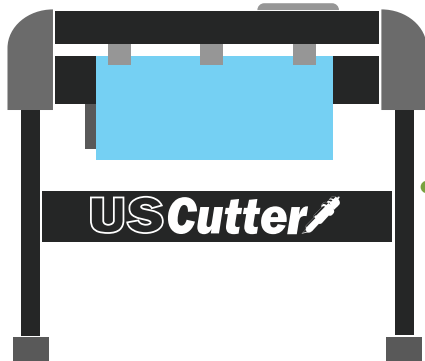

You also need the right media, blade, and application tape to ensure a professional job.



> Oracal 8300, 8500, 8510, & 8800 Transferrite 1320 or R-Tape AT65 45° Blade

Glass Application



> Oracal 3951 & 3651 HP Gloss & Matte GFX-341 45° Blade

Digital Printed Graphics



> Oracal 631 or GreenStar Wall Vinyl Oratape HT55 45° Blade

Indoor Wall Vinyl



> EasyWeed (standard fabrics) 30° Blade (general)
EasyWeed Extra (nylons/water resistant) 60° Blade (glitter/flock)

Heat Press



> Oracal 651 or GreenStar Intermediate (calendered) for short term GreenStar Layflat Classic or Transferrite 582U 45° Blade (general) or 60° Blade (reflective)

Outdoor Signage



> Oramask Paintmask Stencils Oratape HT55 60° Blade

Stencils & Masks

GET EVERYTHING FOR YOUR VINYL CUTTING NEEDS

USCutter

www.uscutter.com
425.481.3555

Warranty Information

USCutter offers a limited 1 year warranty on the Laserpoint 3 cutter.

Details of our standard warranty policy can be viewed on-line at the following link:

www.uscutter.com/Warranty-And>Returns-Policy

Online Help Information for the Laserpoint3

For more information on how to use your Laserpoint3 vinyl cutter, please visit our online Support Portal: support.uscutter.com

Once there, click on “Laserpoint3” in the Vinyl Cutters section!

Another link to the same information is: <https://www.uscutter.com/Laserpoint3-Support>

WE RECOMMEND USAGE OF THE FOLLOWING VINYL
WITH YOUR NEW LASERPOINT3 CUTTER:



COLOR THEORY



Copyright © 2019 USCutter

All rights reserved. No part of this publication may be reproduced, distributed, or transmitted in any form or by any means, including photocopying, recording, or other electronic or mechanical methods, without the prior written permission of the publisher, except in the case of brief quotations embodied in critical reviews and certain other noncommercial uses permitted by copyright law. For permission requests, write to USCutter, 7945 NE 65th St., Suite 200, Redmond, WA 98052

07/09/2019